

Troubleshooting

Table 1: Troubleshooting

| Symptom | Action |
|--|--|
| CSC solid state output does not function | Verify that the maximum amperage range has not been exceeded. Voltages or currents above the rated levels may damage the CSC. |
| Setpoint screw keeps turning | The setpoint screw has a slip clutch to prevent damage at either end. To return the LED to the original setting, turn the setpoint screw 20 full turns counterclockwise and start the calibration procedure again. |
| Motor is turned on and switch does not close | Insufficient current to the load leads (for example, a motor or heater) to reach the setpoint threshold. To turn the switch on, wrap the cable multiple times through the sensing hole (see Figure 3.) |

Technical Specifications

Model CSCGFN150R1 / CSCGA2125R1

| | CSCGFN150R1 | CSCGA2125R1 |
|------------------------------|--|--|
| Amperage Range | 1.5 to 200 A | 1.25 to 135 A |
| Continuous Operating Current | 200 A, 600V AC | 135 A, 600V AC |
| Switch Setpoint | Fixed | Adjustable |
| Output Relay | Single-Pole, Single-Throw (SPST), Normally Open (NO), 10 A @ 260V AC, 5 A @ 30V DC | SPST, NO, 10 A @ 260V AC, 5 A @ 30V DC |
| Switch LED Indication | No | Yes |
| Relay LED Indication | Yes | Yes |
| Actuation Coil | 20 - 30V AC/DC, 32.5 mA Maximum | 20 - 30V AC/DC, 32.5 mA Maximum |
| Current Switching Mode | Under current sensing | Over/Under current sensing |
| Trip Setpoint Mode | 1.5 A | 1.25 to 135 A |
| Sensor Supply Voltage | Induced from power conductor cable | Induced from power conductor cable |
| Status Output | Switch normally open | Switch normally open |
| Switch Load Capacity | 30V AC/DC max., 1 A max. | 30V AC/DC max., 1 A max. |
| Isolation Voltage | 600V AC rms | 600V AC rms |
| Temperature Range | -15 to 60°C (5 to 140°F) | -15 to 60°C (5 to 140°F) |
| Frequency Range | 50/60 Hz | 50/60 Hz |
| Humidity Range | 0 to 95% noncondensing | 0 to 95% noncondensing |
| Dimensions | 2.7 x 2.56 x 1.73 in. (69 x 65 x 44 mm) | 2.7 x 2.56 x 1.73 in. (69 x 65 x 44 mm) |
| Aperture (Sensing Hole) Size | 0.72 x 0.78 in. (18 x 20 mm) | 0.72 x 0.78 in. (18 x 20 mm) |
| Compliance | United States: UL Listed, File E317719, CCN NRNT, Under UL 508, Industrial Control Equipment Canada: UL Listed, File E317719, CCN NRNT7, Under CAN/CAS C22.2 No. 14-05, Industrial Control Equipment Europe: CE Mark LVD 2006/95/EC, EMC Directive 2004/108/EC | |

SSCSC-R Rev. D 04/12/2013

The performance specifications are nominal and conform to acceptable industry standards. For application of conditions beyond these specifications, consult your local Setra representative. Setra Systems, Inc., shall not be liable for damages from misapplication or misuse of its products.

For all CE technical questions, contact Setra Systems, USA. EU customers may contact our EU representative Hengstler GmbH, Uhländstr 49, 78554 Aldingen, Germany (Tel: +49-7424-890; Fax: +49-7424-89500).

59 Swanson Road, Boxborough, MA 01719/800-257-3872;

Fax: 978-264-0292; Email: sales@setra.com/Web: www.setra.com



CSC Series - Current Switch Clamped w/Relay

Model CSCGFN150R1 / CSCGA2125R1

Installation Instructions



Introduction

The Current Switch Clamped (CSC) Series of digital output switches are noninvasive devices designed to detect low current flowing through a cable or wire. A cost effective solution for monitoring on and off status or proof of operation, these units are ideal for monitoring small current loads on motors driving fans and blowers, and for sensing the status of heating coils and lighting.

The snap-on command relay not only monitors current flowing through the cable or wire, but it also enables the remote startup and stopping of the motor.

These units provide a universal solid state output. Excitation is magnetically induced from current carrying conductor (wire or cable), making these units completely self-powered. The command relay requires a separate 24 V AC/DC supply.

IMPORTANT: The Current Switch Clamp (CSC) Series Current Devices are intended to provide an input to equipment under normal operating conditions. Where failure or malfunction of the CSC could lead to personal injury or property damage to the controlled equipment or other property, additional precautions must be designed into the control system. Incorporate and maintain other devices such as supervisory or alarm systems or safety, or limit controls intended to warn of, or protect against, failure or malfunction of the CSC.

Installation



WARNING, Risk of Electric Shock

Disconnect power supply before making electrical connections. Contact with components carrying hazardous voltage can cause electric shock and may result in severe personal injury or death.

Dimensions

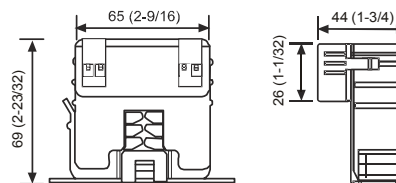

Figure 1: CSC Dimensions mm (in.)

Mounting

1. Using the two screws (included), attach the mounting bracket to the back of the electrical enclosure.

2. Snap the CSC into place on the mounting bracket.

Wiring

1. Disconnect the power to the conductor cable from the power source.

2. Snap the split core around the power conductor cable to be monitored and close the core until the core snaps shut.

3. Wire the CSC/Command Relay as shown in Figure 2.

4. Reconnect the power to the conductor cable.

Note: The switch contacts are solid state, and they work just like dry contacts. When the switch is closed, less than 1 ohm is present; when the switch is open, more than 1 megohm is present.

5. Calibrate Model CSCGA2125R1 (see the [Setup and Adjustments](#)).

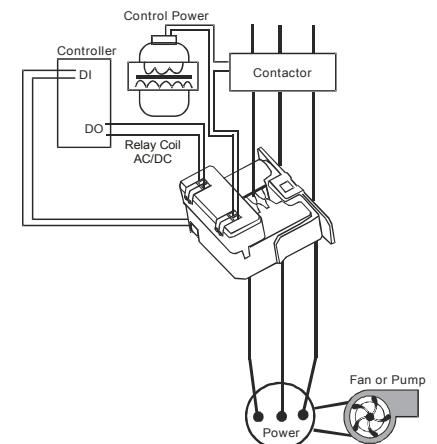

Figure 2: CSCGFN150R1/CSCGA2125R1

If measured current is too low to be detected or is higher than the maximum current rating of the CSC, use the appropriate method to increase or decrease current.

If Measured Current is Too Low to be Detected

Wrap the conductor (wire) through the sensing hole and around the CSC body to produce multiple turns to increase the measured current. Measured current = actual current multiplied by the number of turns (see Figure 3).

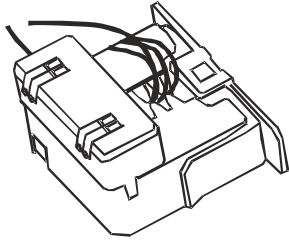

Figure 3: CSC Shown with Four Turns

IMPORTANT: Failure to derate the current capacity may result in damage to the CSC when using multiple turns to increase measured current. Use the following formula to determine the new maximum current:

New Maximum Current = CSC Current Rating/number of turns.
For example, Model CSCGFN150R1 with 4 turns = 135 A/4 = 33.8 A, new maximum current.)

To monitor currents that exceed the maximum current rating of the CSC

For currents >200 A (Model CSCGFN150R1) or >135 A (Model CSCGA2125R1):

Use a 5 A Current Transformer (CT) to reduce the current passing through the CSC (see Figure 4). Run the current transformer secondary wire through the sensing hole. Terminate the two secondary wires of the 5 A current transformer to each other, and then install the 5 A current transformer on the monitored conductor.

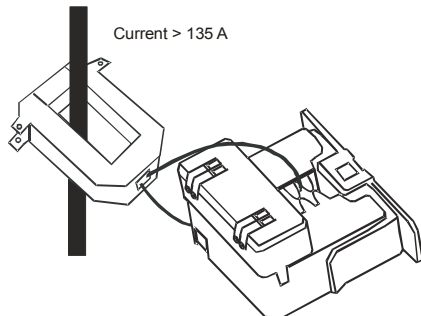

Figure 4: CSC with CT Transformer

Setup and Adjustments Calibration

CSC Series Model CSCGA2125R1

Position the CSC so the status output panel faces you. Confirm the monitored load (for example, a motor or heater) is running, and then use the following methods to calibrate the CSC.

Under current Status Condition (Belt Loss, Coupling Shear, Fan, and Pump Status)

1. Turn the setpoint screw clockwise until the Status Closed Light-Emitting Diode (LED) turns off and the Status Open LED turns on.

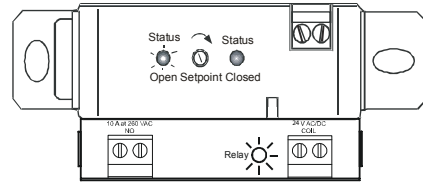

Figure 5: Status Open, LED On

2. Slowly turn the setpoint screw counterclockwise until the Status Closed LED turns on and the Status Open LED turns off.

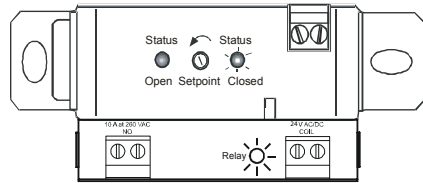

Figure 6: Status Open, LED Off

3. Turn the setpoint screw an additional 1/4 turn counterclockwise to create a deadband to prevent hunting.

The CSC is now calibrated to signal current flows below normal full load amperes.

Output Status:

- Normal: Output Closed
- Alarm: Output: Open

Over Current Status Condition (Locked Rotor, Seized Impeller)

1. Turn the setpoint screw counterclockwise until the Status Open LED turns off and the Status Closed LED turns on.

Note: This is the default factory setting.

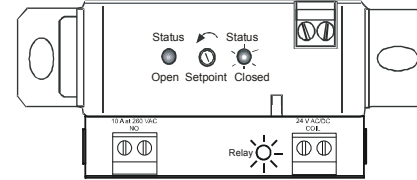

Figure 7: Status Closed, LED On

2. Slowly turn the setpoint screw clockwise until the Status Closed LED turns off and the Status Open LED turns on.

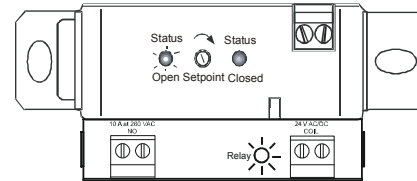

Figure 8: Status Open, LED On

3. Turn the setpoint screw an additional 1/4 turn clockwise to create a deadband to prevent hunting.

The CSC is now calibrated to signal current flows above normal full load amperes.

Output Status:

- Normal: Output Open
- Alarm: Output Closed

RETURNING PRODUCTS FOR REPAIR

Please contact a Setra application engineer (800-257-3872, 978-263-1400) before returning unit for repair to review information relative to your application. Many times only minor field adjustments may be necessary. When returning a product to Setra, the material should be carefully packaged, and shipped to :

Setra Systems, Inc.
159 Swanson Road
Boxborough, MA 01719-1304
Attn: Repair Department

To assure prompt handling, returned unit(s) must be accompanied by Setra's Return Order Form, completely filled out, found on Setra's web site at http://www.setra.com/tra/repairs/cal_rep.htm.

Notes: Please remove any pressure fittings and plumbing that you have installed and enclose any required mating electrical connectors and wiring diagrams.

Allow approximately 3 weeks after receipt at Setra for the repair and return of the unit.

Non-warranty repairs will not be made without customer approval and a purchase order to cover repair charges.

Calibration Services

Setra maintains a complete calibration facility that is traceable to the National Institute of Standards & Technology (NIST). If you would like to recalibrate or recertify your Setra pressure transducers or transmitters, please call our Repair Department at 800-257-3872 (978-263-1400) for scheduling.

WARRANTY AND LIMITATION OF LIABILITY

ETRA warrants its products to be free from defects in materials and workmanship, subject to the following terms and conditions: Without charge, SETRA will repair or replace products found to be defective in materials or workmanship within the warranty period; provided that:

- a) the product has not been subjected to abuse, neglect, accident, incorrect wiring not our own, improper installation or servicing, or use in violation of instructions furnished by SETRA;
- b) the product has not been repaired or altered by anyone except SETRA or its authorized service agencies;
- c) the serial number or date code has not been removed, defaced, or otherwise changed; and
- d) examination discloses, in the judgment of SETRA, the defect in materials or workmanship developed under normal installation, use and service;
- e) SETRA is notified in advance of and the product is returned to SETRA transportation prepaid.

Unless otherwise specified in a manual or warranty card, or agreed to in writing and signed by a SETRA officer, SETRA pressure and acceleration products shall be warranted for one year from date of sale. The foregoing warranty is in lieu of all warranties, express, implied or statutory, including but not limited to, any implied warranty of merchantability for a particular purpose. SETRA's liability for breach of warranty is limited to repair or replacement, or if the goods cannot be repaired or replaced, to a refund of the purchase price. SETRA's liability for all other breaches is limited to a refund of the purchase price. In no instance shall SETRA be liable for incidental or consequential damages arising from a breach of warranty, or from the use or installation of its products.

No representative or person is authorized to give any warranty other than as set out above or to assume for SETRA any other liability in connection with the sale of its products.