

Beyond the Component

CUSTOMIZED FLUIDIC SYSTEMS FOR MEDICAL SCIENCES



It Begins with Your Challenge

For over 60 years, Gems Sensors & Controls has been addressing customers' toughest challenges and providing solutions when a "standard product" just won't do. For these cases, a carefully designed custom engineered system may be the best option. And, with decades of sensor customization experience, there's a good chance that Gems has effectively solved a similar challenge.

- Thermal control systems
- Waste handling systems
- Gas delivery systems
- Liquid delivery systems
- Fluid mixing systems
- Fluid delivery and conditioning systems
- Inventory management systems

When it comes to fluidic management, think of us as an extension to your engineering team. By collaborating with Gems to design and develop custom fluidic systems for your medical device, your fluidics footprint is reduced, required components are minimized and your manufacturing process is greatly simplified. And, with Gems' ability to develop rapid prototypes and validate designs, your time to the fast-paced medical market is accelerated. Whether you need to minimize wasted reagent, protect operators from biohazardous material, or reduce leak points, you can be sure that collaborating with Gems will result in innovation and performance improvements that your customers will enjoy for years to come.

WE WORK WITH YOU

Engineer-to-Engineer, to Develop Medical Fluidic Systems

Start-to-finish Collaboration to Unlock Your Product's Potential

Our structured and scalable process starts with a fluidics workshop where Gems engineers collaborate with you to review fluidic system concept and feasibility. This collaboration continues through design and development where the design is optimized based on your application and end-use requirements. And, since we are a designer and manufacturer, we can pull from our broad sensors line and deep portfolio of technologies to provide enhancements. The optimized design then goes through Gems' pilot production process where dedicated cells are utilized to quickly assess and validate the design. Gems has four fully-equipped ISO certified manufacturing sites (ISO 13485 certification at U.S. headquarters site) to execute our robust commercial manufacturing process.

Uncover the Benefits of a Customized Medical Fluidic System

ACCELERATE TIME TO MARKET

- Unlock innovation potential and reduce the number of design iterations through early-stage collaboration
- Utilize Gems' rapid design process throughout all phases of design from concept through production

SOLVE OEM CHALLENGES

- Reduce the footprint and complexity of your fluidic system
- Design for manufacturing and reduce supply chain complexity through reduced components

OPTIMIZE END-USER EXPERIENCE

- Improve equipment reliability and safety through higher precision, reduced leak points and improved total cost of operation
- Reduce downtime via service-friendly design and modular plug-and-play sub-systems

The Result: Complex to Clean

Gems custom engineered solutions have a smaller foot print and are easier to install and maintain.

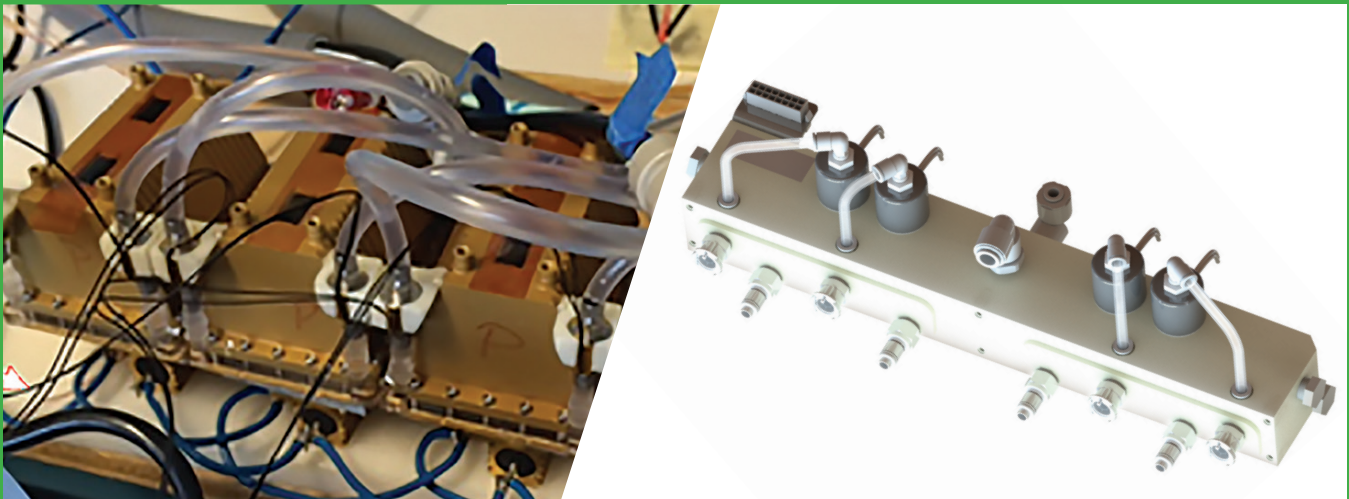

Let us help you turn complex and expensive into compact and cost-effective.

CONCEPT & FEASIBILITY

Our structured, proven process starts with you

Our proven process begins with a Gems Fluidic System™ workshop to help turn your application challenges into advantages. We assemble a dedicated project team specific to your needs and collaborate with you to define the project goals, user requirements and functional specifications. From this, proof of concepts and prototypes are developed to demonstrate product feasibility.

We use a variety of in-house tools to create a Minimum Viable Product (MVP) including:

- 3D Printing
- Solid Modeling
- Rapid Prototyping
- Flow Simulation
- Flow Simulation/Flow FEA analysis

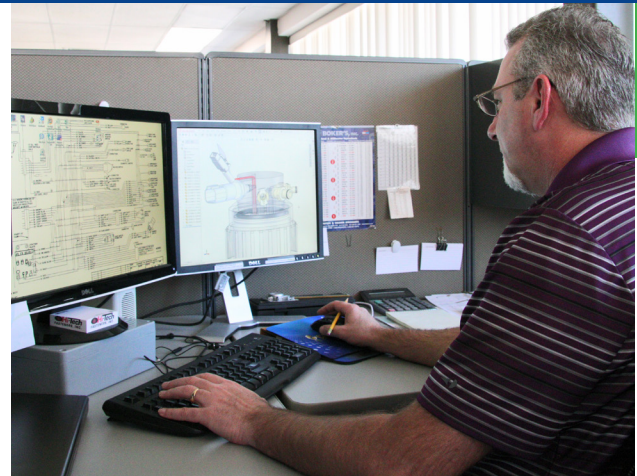
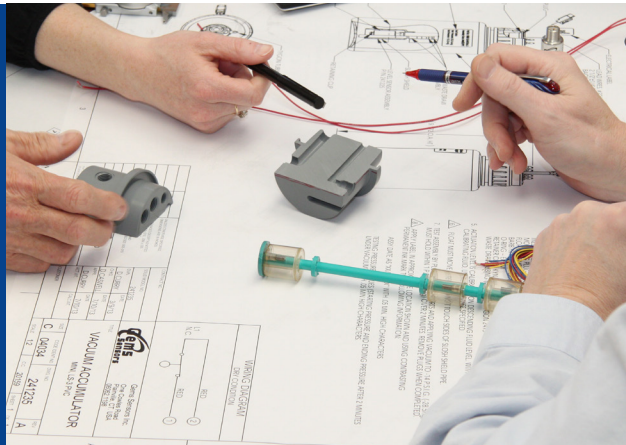

DESIGN & DEVELOPMENT

We understand your end-use application and work with you to optimize design robustness

During design and development, we thoughtfully refine your fluidic system design. We use a variety of tools and tests to do this, including a Design Failure Mode and Effects Analysis (DFMEA) to identify all possible failures to ensure we eliminate them.

Since our process is dedicated to design quality and production readiness, you can be sure the system we design will help you achieve the results you need and eliminate rework later. Plus, since we are a designer and manufacturer, we can pull from our broad sensors line and deep portfolio of technologies to further enhance your design.

At Gems, we know communication is critical to success. You can expect regular communication and meetings with your project team to discuss project status against your plan, critical path forward and risks and countermeasures.

CONCEPT AND FEASIBILITY WORKSHOP

We collaborate with you, engineer-to-engineer, to optimize your design based on the needs of you and your customers.

DESIGN AND DEVELOPMENT

Gems' decades of design experience and deep sensors portfolio ensures that you achieve an innovative and robust fluidic system.

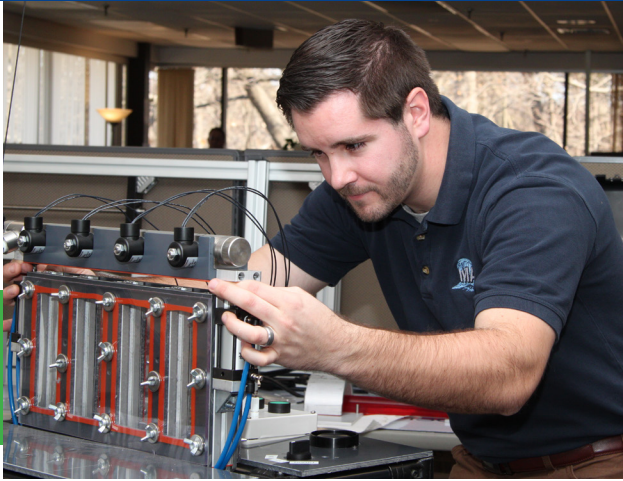

PILOT TRAINING

With our dedicated pilot production team, we validate system designs to your specification

At Gems, we understand manufacturing and how to design for manufacturability. Our objectives include a smooth transition to manufacturing and verification that project goals – quality, delivery, and cost targets – are met. To do this, we set up a dedicated manufacturing area, pilot production/launch team and assembly crew. We create a validation process to ensure prototypes meet customer design requirements, which can include:

- First article inspections
- Process Failure Mode Effects Analysis (PFMEA)
- Manufacturing readiness review
- Life cycle, pressure, leak and RFI/EMI testing
- Shock & vibration (including thermal shock)
- IP/environmental testing
- Accelerated Life (HALT) and Stress (HASS) Testing

PILOT PRODUCTION

Our design-for-manufacturability pre-launch process ensures that your design is ready for production at scale.

COMMERCIAL MANUFACTURING

High-quality, highly repeatable

In the commercial manufacturing stage, we utilize standard work documentation created in pilot production. The Gems operations team finalizes work instructions and all cell documentation (including a resource allocation plan) and implements a material sourcing plan. Depending on our customer's requirements, products are manufactured and tested in a clean environment. Gems has four fully-equipped ISO manufacturing sites (ISO 13485 certification at U.S. headquarters site).

Fundamental to Gems manufacturing system is the Lean philosophy of waste elimination, continuous improvement and client focus which drives world-class quality, shorter production cycle times and quicker customer response time. To do this, we utilize vertically integrated manufacturing:

- Automated coil winders
- Twin spindle Lathes
- 5 Axis machine centers
- Vertical machine centers
- Automated brazing



COMMERCIAL MANUFACTURING

From standard work to lean manufacturing, Gems' commitment to continuous improvement ensures you receive a reliable, turn-key solution.

Case Studies: We address our customers' biggest challenges.



WASTE MANAGEMENT SYSTEM

Challenge

Customer needed to fit their fluidics into their existing footprint while also maximizing the amount of waste held by the bottle, protect operators from biohazardous material and reduce the time-consuming task of waste removal.

Our Solution

- Consolidated multiple waste lines into one vacuum waste system
- Integrated a dual level system and vacuum pump for waste removal without human intervention
- Relocated fittings to allow for zero headroom

Integrated System Design Includes:

- Pressure (vacuum) transducer
- Integrated level controls
- Quick-disconnect inlet fittings
- Siphon tube

Reduced footprint, optimized end user experience.

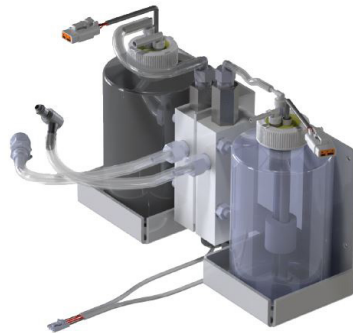

REAGENT MANAGEMENT SYSTEM

Challenge

Customer wanted to be able to remove as much reagent from their bottles as possible while using different flow rates for each bottle.

Our Solution

- Reduced long fluid lines through modular design
- Incorporated flow switches to ensure proper flow from bottle to machine
- Added leak-tight, quick-connect/disconnect fluid connectors for ease of assembly and to eliminate spillage

Integrated System Design Includes:

- High and low-flow sensors
- Continuous liquid level sensors
- Siphon
- Tubes with check valves
- Quick-disconnect fluid fittings
- Bottle
- Mounting bracket

Minimized wasted reagent, reduced assembly time, accelerated time to market.



GAS MIXING SYSTEM

Challenge

Customer needed to improve quality of their equipment's out-put and maintain a common interface across multiple platforms to optimize the end user experience.

Our Solution

- Integrated valves and pressure transducers into one manifold
- Achieved a specific recipe mixture of multiple gases through a precise control by valves
- Delivered continuous pressure monitoring to control the mixing and flow of gases

Integrated System Design Includes:

- Pressure transducers
- Solenoid valves
- Aluminum manifold

Maximized design robustness, optimized end user experience, improved equipment performance.

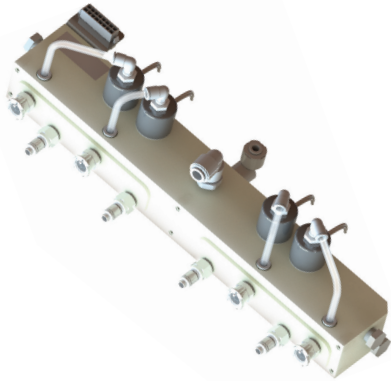

THERMAL CONTROL SYSTEM

Challenge

Customer wanted to reduce the size of their fluidic assembly (to fit into their aggressive equipment footprint), simplify their manufacturing process and reduce leak points.

Our Solution

- Produced concept designs and conducted feasibility assessments to integrate fluidics into aggressive footprint
- Reduced custom components from 9 to 1 to achieve footprint, reduced bill of material components from 29 to 2, reduced potential leak-points from 72 to 10
- Provided internal recirculation, external loops and flow conditioning to achieve desired equipment performance

Integrated System Design Includes:

- Solenoid and check valves
- Flow sensors
- Push-to-connect fittings
- PVC manifold

Reduced footprint, greatly reduced manufacturing complexity, improved end-use performance.

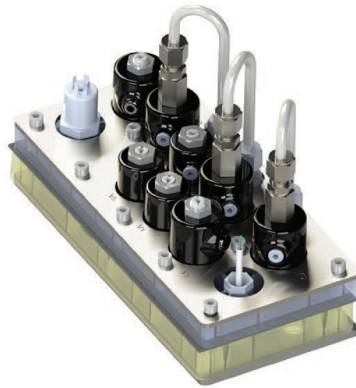

FLUID DELIVERY SYSTEM

Challenge

Customer wanted to design the fluidics for their next generation equipment to fit their desired footprint, optimize end-user experience and make field service repairs easier.

Our Solution

- Produced concept designs and conducted feasibility assessments to achieve desired footprint
- Utilized temperature sensors and pressure transducers to monitor and control fluid
- Incorporated valves to control amount of fluid introduced

Integrated System Design Includes:

- Pressure transducer
- Solenoid valves
- Temperature probes
- Stainless steel manifold with Utem™ fluid channels
- Stainless steel tubing

Accelerated time to market, optimized field service, reduced fluidic systems footprint.

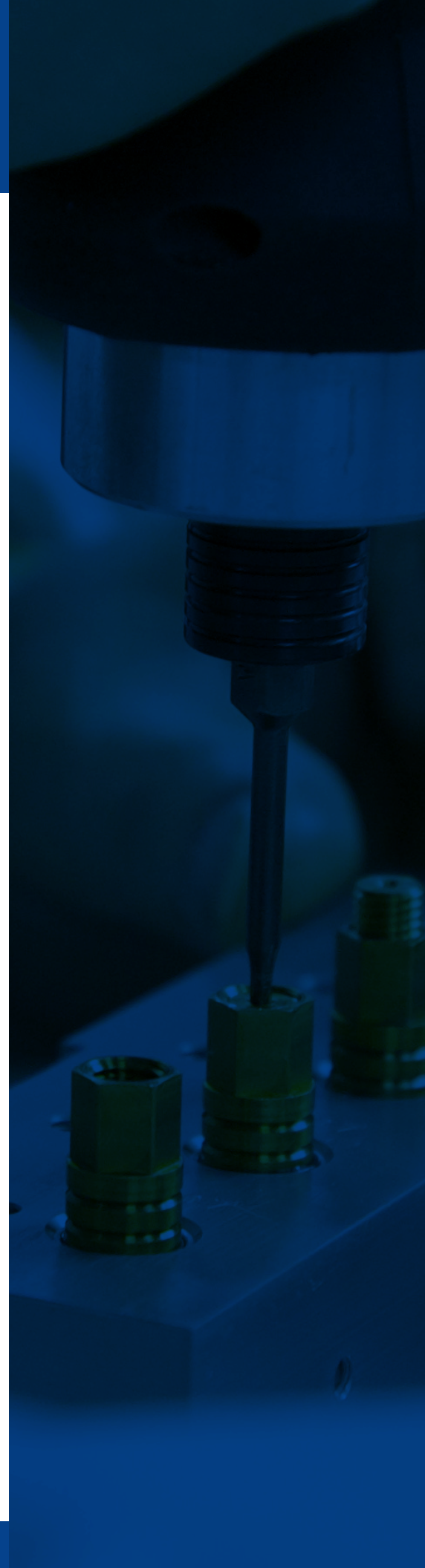



GEMS SENSORS GLOBAL HEADQUARTERS

Toll-Free: +1-855-877-9666
Outside the US: +1-860-747-3000
Email: info@gemssensors.com
www.gemssensors.com

SETRA GLOBAL HEADQUARTERS

Phone: +1-800-257-3872
Email: orders@setra.com
www.setra.com